

Instructions for Use for Qualified Specialists in Orthopaedic Technology Locked System Knee Joints



NEURO LOCK



NEURO FLEX MAX Lock Function



NEURO LOCK MAX



NEURO FLEX MAX Step Lock Function

Download: www.fior-gentz.com

Content	Page
1. Information	4
2. Safety Instructions	4
2.1 Classification of the Safety Instructions	4
2.2 All Instructions for a Safe Handling of the System Knee Joint	4
3. Use	7
3.1 Intended Use	7
3.2 Indication	7
3.3 Contraindication	7
3.4 Qualification	8
3.5 Application	8
3.6 Product Range	8
3.7 Combination Possibilities with Other System Joints	8
4. Joint Function	8
5. Scope of Delivery	9
6. Load	9
7. Tools for Assembling the System Joint	9
8. Assembly Instructions	10
8.1 Mounting the Extension Stop	10
8.2 Mounting the Coil Spring and the Locking Pawl/Step Lock Pawl	11
8.3 Mounting the Cover Plate	11
8.4 Checking the System Joint's Free Movement	12
8.5 Checking the Lock Function	12
8.6 Securing the Screws	13
9. Mounting the Lever Extension	13
10. Adjustment Options on the Orthosis	14
10.1 Locating Pin	14
10.2 Extension Stop and Flexion Stop for the NEURO FLEX MAX Lock Function	14
10.3 Extension Stop and Flexion Stop for the NEURO LOCK MAX and NEURO LOCK	16
10.4 NEURO FLEX MAX Step Lock Function	19
10.5 Alternative Function for the NEURO FLEX MAX Lock Function/Step Lock Function: Limitation of the Maximum Knee Flexion Angle	20
10.6 Alternative Function for the NEURO LOCK: Free Moving, Monocentric System Joint with Integrated Posterior Offset	22
11. Connecting to the System Side Bar/System Anchor	22

12. Converting the System Knee Joints	23
12.1 Conversion Options	23
12.2 Conversion	23
13. Advice on Optimal Orthosis Functionality	24
14. Maintenance	25
14.1 Documentation of Maintenance in the Orthosis Service Passport	26
14.2 Replacing the Sliding Washers	26
14.3 Replacing the Locking Pawl and the Step Lock Pawl	26
14.4 Dirt Removal	26
15. Period of Use	27
16. Storage	27
17. Spare Parts	28
17.1 Exploded View Drawing NEURO LOCK MAX	28
17.2 Exploded View Drawing NEURO FLEX MAX Lock Function	29
17.3 Exploded View Drawing NEURO FLEX MAX Step Lock Function	30
17.4 Spare Parts for the NEURO LOCK System Knee Joint	31
17.5 Spare Parts for the NEURO LOCK MAX System Knee Joint	33
17.6 Spare Parts for the NEURO FLEX MAX System Knee Joint Lock Function	34
17.7 Spare Parts for the NEURO FLEX MAX System Knee Joint Step Lock Function	37
18. Disposal	39
19. Signs and Symbols	39
20. CE Conformity	40
21. Legal Information	40
22. Information for the Treatment Documentation	41
23. Handing Over the Orthosis	42

1. Information

These instructions for use are addressed to qualified specialists in orthopaedic technology and do not contain any notes about dangers which are obvious to them. To achieve maximum safety, please instruct the patient and/or care team in the use and maintenance of the product.





For a simplified illustration, all basic work steps are shown with the **NEURO FLEX MAX** system knee joint with lock function (fig. 1) as example. They can be transferred to all mentioned system joints.



fig. 1

2. Safety Instructions

2.1 Classification of the Safety Instructions

 DANGER	Important information about a possible dangerous situation which, if not avoided, leads to death or irreversible injuries.
 WARNING	Important information about a possible dangerous situation which, if not avoided, leads to reversible injuries that need medical treatment.
 CAUTION	Important information about a possible dangerous situation which, if not avoided, leads to light injuries that do not need medical treatment.
NOTICE	Important information about a possible situation which, if not avoided, leads to damage of the product.

All serious incidents according to Regulation (EU) 2017/745 which are related to the product have to be reported to the manufacturer and to the competent authority of the Member State in which the qualified specialist in orthopaedic technology and/or the patient is established.

2.2 All Instructions for a Safe Handling of the System Knee Joint

DANGER

Potential Traffic Accident Due to Limited Driving Ability

Advise the patient to gather information about all safety and security issues before driving a motor vehicle with orthosis. The patient should be able to drive a motor vehicle safely.

⚠ WARNING

Risk of Falling Due to Improper Handling

Inform the patient about the correct use of the system joint and potential dangers, especially with regards to:

- moisture and water;
- excessive mechanical stress (e.g. due to sports, increased activity or weight gain) and
- unintentional unlocking of the system joint through external influences and a (forceful) unlocking under flexion load.

Also inform the patient that the system joint may only be demounted and maintained by a qualified specialist in orthopaedic technology. Any handling of the system joint and the orthosis by the patient that goes beyond the tasks described in the instructions for use for patients is not permitted.

⚠ WARNING

Risk of Falling Due to Improper Processing

Process the system joint according to the information in these instructions for use. Deviating processing and modifications of the system joint require the written consent of the manufacturer.

⚠ WARNING

Risk of Falling Due to Loosened Screws

Mount the cover plate to the system joint according to the assembly instructions in these instructions for use. Secure the screws with the specified torque and the corresponding adhesive and make sure that no sliding washers are damaged in the process.

⚠ WARNING

Risk of Falling Due to Incorrectly Selected System Components

Make sure that the system joint and the system components are not overloaded and are functionally adapted to the requirements and needs of the patient in order to avoid joint dysfunction.

⚠ WARNING

Risk of Falling Due to Permanent Higher Load

If patient data has changed (e.g. due to weight gain, growth or increased activity), recalculate the expected load on the system joint, plan the treatment again and, if necessary, produce a new orthosis.

⚠ WARNING

Risk of Falling Due to Improper Shoe/Wrong Shoe Pitch

Advise the patient to wear a shoe to which the orthosis is adjusted in order to avoid joint dysfunction.

⚠ WARNING

Risk of Falling Due to Greased Locking Parts

Grease the system joint only slightly. Make sure that no grease enters between locking pawl and stop disc.

WARNING

Risk of Falling Due to Play in the System Joint

In order to achieve a lock function that is free of play, mount the locking parts as described in these instructions for use. In particular, check whether:

- the locking pawl locks properly and
- the degrees of extension stop and stop disc match.

Exchange the locking parts, if necessary.

WARNING

Risk of Falling Due to Insufficient Rigidity of the Orthosis

Ensure sufficient rigidity of the orthosis shells during the production of the orthosis in order to prevent it from bending or distorting over time and thus impairing the lock function.

WARNING

Risk of Falling Due to Incorrectly Adjusted Step Lock Function

For a properly working step lock function, use:

- the 5° step lock stop disc with the 5°, 15° or 25° extension stop,
- the 0° step lock stop disc without extension stop or with the corresponding 10°, 20° or 30° extension stop.

WARNING

Damage to the Anatomical Joint Due to Incorrect Position of the Joint's Mechanical Pivot Point

Determine the joint's mechanical pivot points correctly in order to avoid a permanent incorrect load on the anatomical joint. Please refer to the online tutorials on the FIOR & GENTZ website or contact Technical Support.

WARNING

Breakage of the System Joint Due to Lack of System Anchor

Use a system anchor when producing the orthosis in order to ensure a secure integration of the system joint into the laminate. The system joint may break if it is integrated without a system anchor.

WARNING

Jeopardising the Therapy Goal by Not Providing the Necessary Free Movement

Check if the system joint moves freely in order to avoid restrictions of the joint function. Use suitable sliding washers according to the information in these instructions for use.

NOTICE

Failure of the Lock Function Due to Incorrectly Mounted Lever Extension

Adhere the lever extension to the locking pawl as described in these instructions for use.

NOTICE

Damage to the System Joint Due to Incorrect Filing

When filing the flexion stop, proceed carefully in order to avoid predetermined breaking points (burrs, edges). Pay attention to the markings.

NOTICE

Limitation of the Joint Function Due to Improper Processing

Errors in processing can impair the joint function. Pay particular attention to:

- connect the system side bar/system anchor with the system case in accordance with the production technique and
- adhere to the maintenance intervals.

NOTICE

Limitation of the Joint Function Due to Improper Dirt Removal

Inform the patient on how to properly remove dirt from the orthosis and the system joint.

NOTICE

Limitation of the Joint Function Due to Lack of Maintenance

Respect the specified maintenance intervals in order to avoid joint dysfunction. Also inform the patient about the maintenance appointments to be respected. Enter the next maintenance appointment in the orthosis service passport of the patient.

3. Use

3.1 Intended Use

The FIOR & GENTZ system knee joints are exclusively for use for orthotic fittings of the lower extremity. The system joint is only allowed to be used for producing a KAFO. Every system joint influences the orthosis' function and thus also the function of the leg. The system joint may only be used for one fitting and must not be reused.

3.2 Indication

The indications for the treatment with an orthosis for the lower extremity are insecurities that lead to a pathological gait. This can be caused, for example, by paralyses, structurally conditioned deformities/malfunctions or as a result of physical trauma and/or surgery.

The physical conditions of the patient, such as muscle strength or activity level, are crucial for the orthotic treatment. An evaluation regarding the safe handling of the orthosis by the patient must be carried out.

3.3 Contraindication

The system joint is not suitable for treatments that were not described in paragraph 3.2, such as a treatment of the upper extremity or a treatment with a prosthesis or ortho-prosthesis, for example after amputations of leg segments.

3.4 Qualification

The system joint must only be handled by a qualified specialist in orthopaedic technology.

3.5 Application

All FIOR & GENTZ system joints were developed for everyday life activities such as standing and walking. Extreme impact stress, which occurs for example during long jump, climbing and parachuting, is excluded.

3.6 Product Range

These instructions for use provide information on the following system knee joints:

	NEURO LOCK		NEURO FLEX MAX lock function
	NEURO LOCK MAX		NEURO FLEX MAX step lock function

3.7 Combination Possibilities with Other System Joints

The system knee joints can be combined with other system joints from the FIOR & GENTZ product range. The NEURO VARIO system knee joint can be used as supporting joint for the NEURO LOCK MAX, NEURO FLEX MAX with lock function and NEURO FLEX MAX with step lock function.

We recommend that you use the Orthosis Configurator when selecting all system components for your orthosis and follow the recommendations of the configuration result.

4. Joint Function

The system knee joints have the following functions depending on the used system components:

System Component	Function	System Joint
locating pin	permanent unlocking of the system knee joint	NEURO LOCK MAX NEURO FLEX MAX lock function NEURO FLEX MAX step lock function
extension stop	limitation of the maximum extension in different degrees (0°, 5°, 10°, 15°, 20°, 25°, 30°). For NEURO LOCK, the degrees 15° and 25° are not applicable.	NEURO LOCK NEURO LOCK MAX NEURO FLEX MAX lock function NEURO FLEX MAX step lock function
flexion stop (adjustable by filing the joint's lower part)	locking in different flexion positions (5° premounted)	NEURO LOCK NEURO LOCK MAX

System Component	Function	System Joint
flexion stop (exchangeable flexion stop disc)	locking in different flexion positions (5°, 10°, 15°, 20°, 25° or 30° premounted)	NEURO FLEX MAX lock function
System Component	Function	System Joint
step lock parts (step lock pawl and step lock stop disc)	gradual locking in 10° steps	NEURO FLEX MAX step lock function
System Component	Function	System Joint
flexion stop disc AF (alternative function)	limitation of the maximum knee flexion angle	NEURO FLEX MAX lock function NEURO FLEX MAX step lock function

5. Scope of Delivery

Description	Quantity
system knee joint (without figure)	1
pan head screw for exchanging extension stops (fig. 2)	1
orthosis joint grease, 3g (without figure)	1
assembly/lamination dummy (fig. 3)	1
lever extension (without figure)	1
connecting tube for lever extension (without figure)	1

6. Load

The actual load on the system joints is based on the relevant patient data. The load and the appropriate system components can be determined by using the Orthosis Configurator. We recommend that you use the system components determined by the Orthosis Configurator when producing an orthosis and mind the recommended production technique. You will find information on the production techniques in the section "Online Tutorials" on the FIOR & GENTZ website.



fig. 2



fig. 3

7. Tools for Assembling the System Joint

Tools for System Joint Screws	System Width			
	12mm	14mm	16mm	20mm
T15 hexalobular screwdriver/bit	x	x	x	-
T20 hexalobular screwdriver/bit	-	x	x	x
torque screwdriver, 1–6Nm	x	x	x	x
slotted screwdriver, 2 x 0.4mm	x	x	x	x
slotted screwdriver, 2.5 x 0.4mm	x	x	x	x

Tools for System Joint Screws	System Width			
	12mm	14mm	16mm	20mm
slotted screwdriver, 3,5 x 0,6mm	x	x	x	x

Tools for Pan Head Screw for Exchanging the Extension Stops	System Width			
	12mm	14mm	16mm	20mm
T8 hexalobular screwdriver	x	x	-	-
T10 hexalobular screwdriver	-	-	x	x

8. Assembly Instructions

The system joint is delivered fully assembled. All functions are checked beforehand. You have to disassemble the system joint for mounting it in the orthosis and for maintenance. To ensure an optimal functioning, follow the assembly instructions below. Secure all screws with the torque specified in paragraph 8.6.

You can find more information on the assembly in the online tutorial **Joint Assembly NEURO FLEX MAX, NEURO LOCK, NEURO LOCK MAX** (see QR code, fig. 4) on the FIOR & GENTZ website.



fig. 4

In the following, the assembly is illustrated with the **NEURO FLEX MAX** system knee joint with lock function as an example.

i The locking pawls/step lock pawls are assigned to specific system joints. You will find the article number of the premounted locking pawl/step lock pawl on the back page of these instructions for use.

i Only use the FIOR & GENTZ orthosis joint grease to grease the system components.

8.1 Mounting the Extension Stop

In order to demount and mount the extension stop, proceed as follows:

- 1 Screw the pan head screw through the threaded hole in the back of the joint's upper part (fig. 6).
- 2 Press out the extension stop.
- 3 Remove the pan head screw.
- 4 Put the new extension stop into the joint's upper part.
- 5 Press the extension stop into the joint's upper part by using a vice with braces.

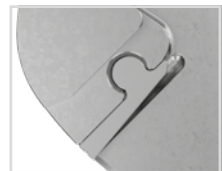

fig. 5

i If you would like to mount a different extension stop than the premounted 5° stop (fig. 5), note the information in paragraph 10.2.



fig. 6

8.2 Mounting the Coil Spring and the Locking Pawl/ Step Lock Pawl

- 1 Before the assembly, clean the threads of the bearing nut and of the joint's upper part as well as the bores of the cover plate with LOCTITE® 7063 Super Clean. Allow the threads to air-dry for 10 minutes.
- 2 Do not demount the pressure screw (fig. 7).
- 3 Insert the coil spring from below into the spring duct of the joint's upper part (fig. 8).
- 4 Grease the axle bore of the locking pawl/step lock pawl and the sliding surfaces of the pawl's bearing nut with orthosis joint grease.
- 5 Put the bearing nut for the locking pawl/step lock pawl into the intended opening of the joint's upper part (fig. 9).
- 6 Mount the locking pawl/step lock pawl (fig. 10).

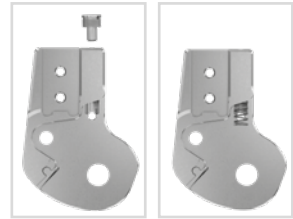

fig. 7

fig. 8

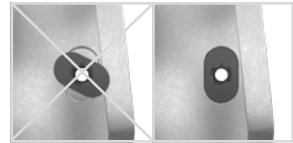

fig. 9

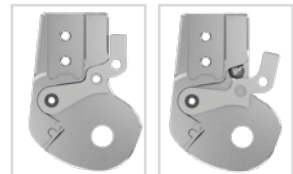

fig. 10

fig. 11



fig. 12

fig. 13

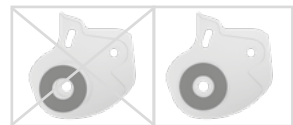

fig. 14

You can find more information on the assembly in the online tutorial Joint Assembly NEURO FLEX MAX Step Lock Function (see QR code, fig. 13) on the FIOR & GENTZ website.

8.3 Mounting the Cover Plate

Make sure not to damage the sliding washer during assembly. Jammed sliding washer particles can cause lateral play in the system joint.

- 1 Apply spray adhesive on one side of the first sliding washer and adhere it to the cover plate (fig. 14).
- 2 Grease the other side **slightly** with orthosis joint grease.
- 3 For system joints with flexion stop disc/step lock stop disc: press it to the joint's lower part (fig. 15).
- 4 Grease the axle bore of the joint axis and the sliding surfaces of the bearing nut of the joint axis with orthosis joint grease.

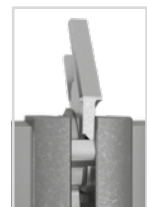

fig. 15

- 5 Put the bearing nut of the joint axis into the opening of the joint's upper part (fig. 16).
- 6 Grease the second sliding washer slightly on both sides with orthosis joint grease.
- 7 Place the sliding washer onto the joint's upper part (fig. 17).
- 8 Mount the joint's lower part (fig. 18). For a simplified mounting to the **NEURO LOCK** system knee joint, make sure that the system joint is flexed.
- 9 Place the cover plate on the system joint.



fig. 16

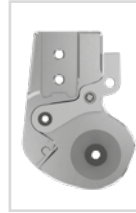

fig. 17

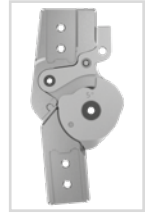

fig. 18



Some **NEURO LOCK** cover plates do not have a hollow for the sliding washer due to manufacturing reasons. Position the second sliding washer in such a way that the bore for the bearing nut is not covered.

- 10 Screw in the first countersunk flat head screw (axle screw, S1; fig. 19).
- 11 Screw in the second countersunk flat head screw (S2; fig. 20).

8.4 Checking the System Joint's Free Movement

Tighten the screws for the cover plate with the appropriate torque (see paragraph 8.6). Check if the system joint moves freely. If the system joint runs with lateral play, mount the next thicker sliding washer. If it does not move freely (it is jammed), mount the next thinner sliding washer.



fig. 19

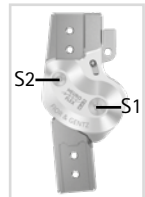

fig. 20

8.5 Checking the Lock Function

- 1 Lock the system joint in maximum extension.
- 2 Press the locking pawl downwards firmly. The extension stop is thus pressed against the stop faces.
- 3 Unlock the system joint again and have the locking pawl snap as usual. You should hear a distinct "click" when the system joint locks.
- 4 Check the correct position of the locking pawl. It must not be mounted too high (fig. 21) or too low (fig. 22).



fig. 21



fig. 22

If the locking pawl is in the correct position (fig. 23), the system joint locks without play. If the locking pawl is mounted too low, the system joint locks with play. In this case, mount the next longer locking pawl with the same system width and check the fit. If the locking pawl is mounted too high, the system joint might unlock unintentionally. In this case, mount the next shorter locking pawl with the same system width and check the fit.



fig. 23

8.6 Securing the Screws

The screws are secured after the orthosis has been produced and tried on and before it is handed over to the patient.

- 1 Loosen the screws for the cover plate (fig. 20) after checking the system joint's free movement and remove them from the cover plate.
- 2 Apply a small drop of LOCTITE® 243 medium strength to the thread of the screws.
- 3 Secure the screws for the cover plate (fig. 20) with the torque corresponding to the system width.
- 4 Let the adhesive harden (final strength after approx. 24 hours).

Screws for NEURO LOCK Cover Plate	System Width		
	14mm	16mm	20mm
S1 (screw 1, axle screw)	3Nm	4Nm	4Nm
S2 (screw 2)	3Nm	3Nm	3Nm

Screws for NEURO LOCK MAX/ NEURO FLEX MAX Cover Plate	System Width			
	12mm	14mm	16mm	20mm
S1 (screw 1, axle screw)	3Nm	4Nm	4Nm	4Nm
S2 (screw 2)	3Nm	3Nm	3Nm	4Nm



The screws for the cover plate are not secured with the necessary torque at delivery. You can also find information on the torque in the openings of the cover plate.

9. Mounting the Lever Extension

The lever extension is used for an easy unlocking of the system knee joint. Please note that the NEURO LOCK system joint can only be mounted bilaterally.

Unilateral Construction

- 1 Adapt the lever extension to the shape of the orthosis and shorten it, if necessary.
- 2 Apply LOCTITE® 638 high strength to the shoulder of the lever extension and connect it with the locking pawl (fig. 24).



fig. 24

Bilateral Construction

- 1 Adapt the lever extensions to the shape of the orthosis.
- 2 Connect the lever extensions at a distance of approx. 1mm by means of the connecting tube for lever extension (fig. 25).
- 3 Apply LOCTITE® 638 high strength to the shoulders of the lever extensions and connect them with the locking pawls (fig. 24).

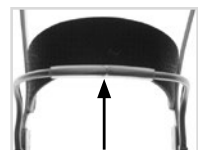

fig. 25

The adhesion is sturdy after approx. 1 hour. It has completely hardened after approx. 24 hours (at room temperature).

10. Adjustment Options on the Orthosis

10.1 Locating Pin

System joints with locating pin (fig. 27/A) can be used as free moving joints with an integrated posterior offset by means of the permanent unlock function (fig. 26).

System Width	12mm	14mm	16mm	20mm
Posterior Offset of the Joint Axis	12mm	14mm	16mm	20mm

The lock function can be disabled permanently by means of the locating pin.

- 1 Press the locking pawl against the joint's upper part.
- 2 Hold the locking pawl in this position.
- 3 In order to obtain a free moving system joint, push the locating pin into the locking pawl until it snaps into the joint's upper part.

In order to disable the permanent unlock function, the patient must extend their knee and the locking pawl must be pressed against the joint's upper part again. By doing so, the locating pin is automatically pushed out.

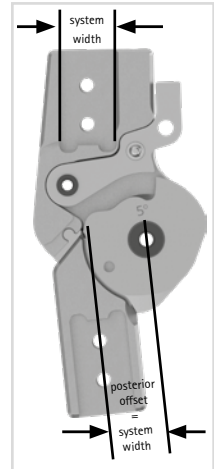

fig. 26

10.2 Extension Stop and Flexion Stop for the NEURO FLEX MAX Lock Function

The extension stop (fig. 27/B) is exchangeable. It can be mounted into the system joint depending on the desired extension.

The extension stop and the flexion stop must always match each other. After replacing the extension stop (fig. 28), the flexion stop disc must be inserted according to the chosen degree.

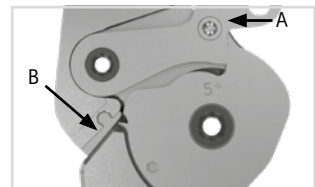

fig. 27

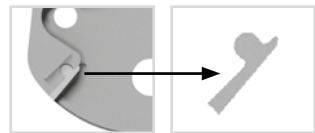

fig. 28



fig. 29

i When mounting the extension stop, mind the correct alignment of the entire orthosis. In order for an exchanged extension stop not to affect the orthosis alignment negatively, also correct the system ankle joint, if necessary. You can find more information on the orthosis alignment in the online tutorial **KAFO Alignment Guidelines** (see QR code, fig. 29) on the FIOR & GENTZ website.

NEURO FLEX MAX Lock Function (Fig. 27)

Current Extension	Desired Extension	Required Extension Stop	Required Flexion Stop Disc	Work Steps
5°, 10°, 15°, 20°, 25° or 30°	0°	none	0° flexion stop disc	- removing the extension stop - replacing the flexion stop disc
0°, 10°, 15°, 20°, 25° or 30°	5°	5° extension stop	5° flexion stop disc	- replacing the extension stop - replacing the flexion stop disc
0°, 5°, 15°, 20°, 25° or 30°	10°	10° extension stop	10° flexion stop disc	
0°, 5°, 10°, 20°, 25° or 30°	15°	15° extension stop	15° flexion stop disc	
0°, 5°, 10°, 15°, 25° or 30°	20°	20° extension stop	20° flexion stop disc	
0°, 5°, 10°, 15°, 20° or 30°	25°	25° extension stop	25° flexion stop disc	
0°, 5°, 10°, 15°, 20° or 25°	30°	30° extension stop	30° flexion stop disc	
<p>Note: always check the lock function afterwards (see paragraph 8.5) and, if necessary, replace the locking pawl. Finally, check the orthosis alignment and, if necessary, adjust the angle between the lower leg and the floor.</p>				

10.3 Extension Stop and Flexion Stop for the NEURO LOCK MAX and NEURO LOCK

The flexion angle can be adjusted as required by exchanging the extension stop and filing the joint's lower part. The extension stop can be exchanged depending on the desired extension.

The extension stop and the flexion stop must always match each other. After replacing the extension stop (**NEURO LOCK MAX**, fig. 30/A; **NEURO LOCK**, fig. 31/A), the joint's lower part must be filed according to the chosen degree. For filing, you will find auxiliary lines on the flexion stop (fig. 30/B and fig. 31/B). You can find further information in the following table.

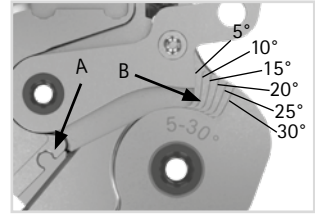

fig. 30

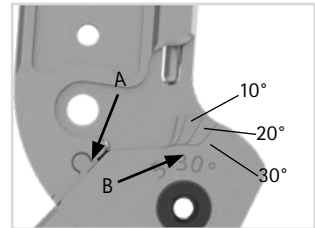

fig. 31

i If you wish to use the system joint with a smaller flexion than the one you have already filed, you must mount a new joint's lower part.

NEURO LOCK MAX (Fig. 30)

Current Extension	Desired Extension	Required Extension Stop	Required Joint's Lower Part	Work Steps
5°, 10°, 15°, 20°, 25° or 30°	0°	none	0° joint's lower part	<ul style="list-style-type: none"> - removing the extension stop - replacing the joint's lower part - checking the lock function (replacing locking pawl, if necessary) - checking the orthosis alignment (increasing the angle between the lower leg and the floor, if necessary)
0°	5°	5° extension stop	5° joint's lower part, if necessary	<ul style="list-style-type: none"> - replacing the extension stop - adjusting the flexion stop by filing the joint's lower part (mounting 5° joint's lower part, if necessary) - checking the lock function (replacing the locking pawl, if necessary) - checking the orthosis alignment (adapting the angle between the lower leg and the floor, if necessary)

Current Extension	Desired Extension	Required Extension Stop	Required Joint's Lower Part	Work Steps
0° or 5°	10°	10° extension stop	none	<ul style="list-style-type: none"> - replacing the extension stop - adjusting the flexion stop by filing the joint's lower part - checking the lock function (replacing the locking pawl, if necessary) - checking the orthosis alignment (adapting the angle between the lower leg and the floor, if necessary)
0°, 5° or 10°	15°	15° extension stop	none	
0°, 5°, 10° or 15°	20°	20° extension stop	none	
0°, 5°, 10°, 15° or 20°	25°	25° extension stop	none	
0°, 5°, 10°, 15°, 20° or 25°	30°	30° extension stop	none	
10°, 15°, 20°, 25° or 30°	5°, 10°, 15°, 20°, 25° or 30°	5°, 10°, 15°, 20°, 25° or 30° extension stop	5° joint's lower part	<ul style="list-style-type: none"> - replacing the extension stop - replacing the joint's lower part - adjusting the flexion stop by filing the joint's lower part, if necessary - checking the lock function (replacing the locking pawl, if necessary) - checking the orthosis alignment (adapting the angle between the lower leg and the floor, if necessary)

Note: always check the lock function afterwards (see paragraph 8.5) and, if necessary, replace the locking pawl. Finally, check the orthosis alignment and, if necessary, adjust the angle between the lower leg and the floor.

NEURO LOCK (Fig. 31)

Current Extension	Desired Extension	Required Extension Stop	Required Joint's Lower Part	Work Steps
5°, 10°, 20° or 30°	0°	none	0° joint's lower part	<ul style="list-style-type: none"> - removing the extension stop - replacing the joint's lower part
0°	5°	5° extension stop	5° joint's lower part, if necessary	<ul style="list-style-type: none"> - replacing the extension stop - adjusting the flexion stop by filing the joint's lower part (mounting 5° joint's lower part, if necessary)
0° or 5°	10°	10° extension stop	none	<ul style="list-style-type: none"> - replacing the extension stop - adjusting the flexion stop by filing the joint's lower part
0°, 5° or 10°	20°	20° extension stop	none	
0°, 5°, 10° or 20°	30°	30° extension stop	none	
10°, 20° or 30°	5°, 10°, 20° or 30°	5°, 10°, 20° or 30° extension stop	5° joint's lower part	<ul style="list-style-type: none"> - replacing the extension stop - replacing the joint's lower part - adjusting the flexion stop by filing the joint's lower part, if necessary
<p>Note: always check the lock function afterwards (see paragraph 8.5) and, if necessary, replace the locking pawl. Finally, check the orthosis alignment and, if necessary, adjust the angle between the lower leg and the floor.</p>				

10.4 NEURO FLEX MAX Step Lock Function

The NEURO FLEX MAX system knee joint with step lock function locks gradually during extension. The toothings of the step lock stop disc and the step lock pawl enable the gradual locking of the system joint in 10° steps up to a maximum of 55° (fig. 32). A 5° extension stop and a 5° step lock stop disc are premounted.

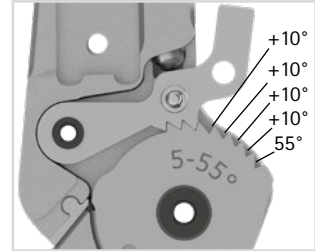

fig. 32



The 5°, 15° and 25° extension stops require the 5°–55° step lock stop disc. The 10°, 20° and 30° extension stops require the 0°–60° step lock stop disc.

NEURO FLEX MAX Step Lock Function (Fig. 32)

Current Extension	Desired Extension	Required Extension Stop	Required Step Lock Stop Disc	Work Steps
5°, 15° or 25°	0°	none	0°–60° step lock stop disc	- removing the extension stop - replacing the step lock stop disc
10°, 20° or 30°	0°	none	none	- removing the extension stop
5°, 15° or 25°	5°, 15° or 25°	5°, 15° or 25° extension stop	none	
0°, 10°, 20° or 30°	5°, 15° or 25°	5°, 15° or 25° extension stop	5°–55° step lock stop disc	- replacing the extension stop
5°, 15° or 25°	0°, 10°, 20° or 30°	10°, 20° or 30° extension stop	0°–60° step lock stop disc	- replacing the step lock stop disc
0°, 20° or 30°	0°, 10°, 20° or 30°	10°, 20° or 30° extension stop	none	- replacing the extension stop

Note: always check the step lock function afterwards and, if necessary, replace the step lock pawl. Finally, check the orthosis alignment and, if necessary, adjust the angle between the lower leg and the floor.

10.5 Alternative Function for the NEURO FLEX MAX Lock Function/Step Lock Function: Limitation of the Maximum Knee Flexion Angle

With the flexion stop disc AF you can limit the maximum knee flexion angle when the system joint is unlocked.

- NEURO FLEX MAX Lock Function:** exchange the premounted flexion stop disc and cover plate for the flexion stop disc AF and cover plate AF.

NEURO FLEX MAX Step Lock Function: exchange the premounted step lock pawl, step lock stop disc and cover plate for the locking pawl, flexion stop disc AF and cover plate AF.

- Set the desired maximum knee flexion angle of 60°, 70°, 80° or 90° by filing. To do so, use the auxiliary lines on the flexion stop disc AF (fig. 33).

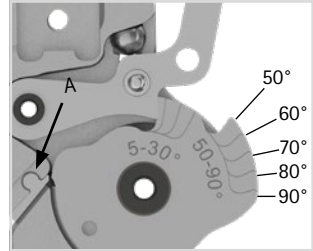

fig. 33

The extension stop can be exchanged depending on the desired extension. The extension stop and the flexion stop must always match each other. After replacing the extension stop (fig. 33/A), the flexion stop disc must be filed according to the chosen degree. For filing, you will find auxiliary lines on the flexion stop (fig. 33). You can find further information in the following table.

NEURO FLEX MAX Alternative Function (Fig. 33)

Current Extension	Desired Extension	Required Extension Stop	Required Flexion Stop Disc Alternative Function	Work Steps
5°, 10°, 15°, 20°, 25° or 30°	0°	none	0° flexion stop disc	<ul style="list-style-type: none"> - removing the extension stop - replacing the flexion stop disc - checking the lock function (replacing the locking pawl, if necessary) - checking the orthosis alignment (increasing the angle between the lower leg and the floor, if necessary)
0°	5°	5° extension stop	5° joint's flexion stop disc, if necessary	<ul style="list-style-type: none"> - replacing the extension stop - adjusting the flexion stop by filing the flexion stop disc (mounting 5° flexion stop disc, if necessary) - checking the lock function (replacing the locking pawl, if necessary) - checking the orthosis alignment (adapting the angle between the lower leg and the floor, if necessary)

Current Extension	Desired Extension	Required Extension Stop	Required Flexion Stop Disc Alternative Function	Work Steps
0° or 5°	10°	10° extension stop	none	<ul style="list-style-type: none"> - replacing the extension stop - adjusting the flexion stop by filing the flexion stop disc - checking the lock function (replacing the locking pawl, if necessary) - checking the orthosis alignment (adapting the angle between the lower leg and the floor, if necessary)
0°, 5° or 10°	15°	15° extension stop	none	
0°, 5°, 10° or 15°	20°	20° extension stop	none	
0°, 5°, 10°, 15° or 20°	25°	25° extension stop	none	
0°, 5°, 10°, 15°, 20° or 25°	30°	30° extension stop	none	
10°, 15°, 20°, 25° or 30°	5°, 10°, 15°, 20°, 25° or 30°	5°, 10°, 15°, 20°, 25° or 30° extension stop	5° flexion stop disc	<ul style="list-style-type: none"> - replacing the extension stop - replacing the flexion stop disc - adjusting the flexion stop by filing the flexion stop disc, if necessary - checking the lock function (replacing the locking pawl, if necessary) - checking the orthosis alignment (adapting the angle between the lower leg and the floor, if necessary)

Note: always check the lock function afterwards (see paragraph 8.5) and, if necessary, replace the locking pawl. Finally, check the orthosis alignment and, if necessary, adjust the angle between the lower leg and the floor. The flexion limitation is filed independently from the degree of extension.

You can find more information on the alternative function in the online tutorial Joint Assembly NEURO FLEX MAX Alternative Function (see QR code, fig. 34) on the FIOR & GENTZ website.



fig. 34

10.6 Alternative Function for the NEURO LOCK: Free Moving, Monocentric System Joint with Integrated Posterior Offset

If the lock function is no longer needed, the NEURO LOCK can be used as a free moving system knee joint with integrated posterior offset (fig. 36).

System Width	14mm	16mm	20mm
Posterior Offset of the Joint Axis	14mm	16mm	20mm

For converting the system joint, remove the locking pawl, the coil spring and the ball (fig. 35).



The bearing nut of the locking pawl must remain in the system joint in order to secure the cover plate with the countersunk flat head screw.



fig. 35

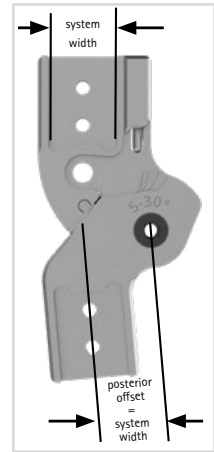

fig. 36

11. Connecting to the System Side Bar/System Anchor

The system side bar/system anchor must be connected to the system joint by adhering and screwing or screwing and wrapping in accordance with the production technique provided in the planning (fig. 37–39).

You can find more information in the **Instructions for Use for Qualified Specialists in Orthopaedic Technology System Side Bars and System Anchors** (see QR code, fig. 40). You will find information on the production techniques in the section "Online Tutorials" on the FIOR & GENTZ website.



fig. 37



fig. 38



fig. 39



fig. 40

12. Converting the System Knee Joints

12.1 Conversion Options

The following table shows the conversion options for the system knee joints.

System Knee Joint	Convertible into
NEURO FLEX MAX lock function	NEURO FLEX MAX step lock function
NEURO FLEX MAX step lock function	NEURO FLEX MAX lock function

12.2 Conversion

- 1 Exchange the locking pawl for the step lock pawl (fig. 41).
- 2 Exchange the flexion stop disc for the step lock stop disc (fig. 42).
- 3 Assemble the system joint (see paragraph 8).

In order to convert the **NEURO FLEX MAX** system knee joint with step lock function into the **NEURO FLEX MAX** system knee joint with lock function, exchange the step lock parts for the locking parts. Proceed as described in the steps 1 to 3.

Check if the locking pawl/step lock pawl fits correctly (see paragraph 8.5). After inserting the step lock pawl and the step lock stop disc, check if the step lock pawl snaps correctly.

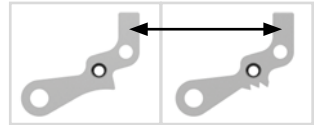

fig. 41

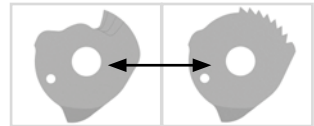

fig. 42

13. Advice on Optimal Orthosis Functionality

Problem	Cause	Measure
The system joints do not unlock.	The locking and unlocking parts are still loaded.	The patient has to take the body weight off of the orthosis (e.g. by sitting down on a chair).
	The patient does not apply a minimal extension moment.	The patient has to take the body weight off of the orthosis (e.g. by sitting down on a chair) and has to apply an extension moment himself or with the assistance of another person (e.g. by pushing the knee backwards).
The system joints do not lock correctly.	The orthosis is not torsion-resistant (bilateral construction). Only one system joint locks.	The system joints must be locked with passive force. The patient or another person must push the knee backwards.
	One system joint is/both system joints are still in permanent unlock function.	The locking pawl must be pressed against the joint's upper part until the locating pin is pushed out of its bore in the joint's upper part. The patient must fully extend their knee until the system joint locks.
The system joints do not lock correctly in step lock function.		Retry unlocking and locking the system joint.
	The step lock pawls lock in different flexion positions.	Please note that a 5° extension stop and a 5° step lock stop disc are mounted for the premounted step lock function. Use a 0° step lock stop disc for other extension stops.
	Extension stops with different extension degrees (e.g. medial 10° and lateral 20°) have been mounted.	Only mount extension stops with the same degree of extension.
	The orthosis is not properly produced (e.g. not torsion-resistant, no parallel alignment of the system joints).	Correct the alignment of the orthosis.

14. Maintenance

Check the system joint regularly for wear and functionality. In particular, check the joint components listed in the following table for the possible problems described and, if necessary, take the appropriate measures. Also check the functionality after every maintenance carried out. It must be possible to move the system joint without problems or unusual noises. Make sure that there is no lateral play.

Joint Component	Potential Problem	Measure	Recommended Inspection, Potential Replacement*	Latest Replacement
sliding washer	wear	replacing sliding washer, see paragraph 14.2	every 6 months	every 18 months
sliding bushing	wear	replacing sliding bushing	every 6 months	every 18 months
coil spring	wear	replacing coil spring	every 6 months	every 18 months
step lock pawl and step lock stop disc	wear of the detents	replacing step lock pawl and step lock stop disc, see paragraph 14.3	every 6 months	every 18 months
cover plate	wear	replacing cover plate	every 6 months	every 36 months
countersunk flat head screw with hexalobular socket	wear	replacing countersunk flat head screw	every 6 months	every 36 months
bearing nut	wear	replacing bearing nut	every 6 months	every 36 months
locking pawl	wear	replacing locking pawl, see paragraph 14.3	every 6 months	every 36 months
pulling cable	wear	replacing pulling cable	every 6 months	every 36 months
extension stop	wear	replacing extension stop, see paragraph 8.1	every 6 months	if required

* depending on the assessment of the distributor of the custom-made product regarding the patient's usage behaviour

Clean the threads of the bearing nuts and of the joint's upper part as well as the bores of the cover plate with LOCTITE® 7063 Super Clean at every maintenance. Allow the threads to air-dry for 10 minutes.

Secure the screws for the cover plate with the appropriate torque and LOCTITE® 243 medium strength, during every maintenance (see paragraph 8.6). Remove all adhesive residues first.

Further Information on the pulling cables can be found in the Instructions for Use for Qualified Specialists in Orthopaedic Technology Pulling Cables.

You can find the individual maintenance plans for system joints in the download area (see QR code, fig. 43) on the FIOR & GENTZ website.



fig. 43



The step lock pawl and step lock stop disc are subject to faster wear. This may result in shorter maintenance intervals.

14.1 Documentation of Maintenance in the Orthosis Service Passport

The patient receives an orthosis service passport (fig. 44) from a qualified specialist in orthopaedic technology when the orthosis is handed over. The orthosis must be checked regularly according to the specifications in the maintenance plan in order to maintain its function and to ensure the safety of the patient. The maintenance appointments are noted and confirmed in the orthosis service passport.



fig. 44

14.2 Replacing the Sliding Washers

Sliding washers are available in different thicknesses (e.g. GS2210-040 is 0.40mm thick). Each thickness has a different marking (fig. 45). You will find the article numbers of the premounted sliding washers on the back page of these instructions for use.

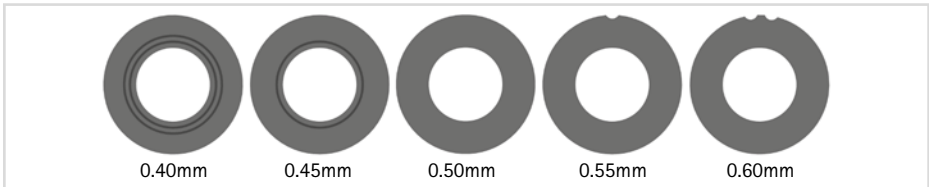

fig. 45

14.3 Replacing the Locking Pawl and the Step Lock Pawl

If the locking pawl/step lock pawl or the stop disc/joint's lower part wears out, the premounted pawl has to be exchanged for a longer one. You can find the article number of the premounted pawl on the back page of these instructions for use. The length is lasered onto the pawl. The higher the last three digits of the article number are, the longer the pawl is (fig. 46). The step lock pawl and step lock stop disc must always be exchanged together.



fig. 46

14.4 Dirt Removal

Dirt must be removed from the system joint when necessary and during regular maintenance. For this purpose, disassemble the system joint and clean the soiled system components with a dry cloth.

15. Period of Use

To guarantee a safe use and complete functionality as well as an unlimited period of use of the system joints, you must adhere to the following conditions:

- Adhere to the specified maintenance intervals without interruption and document each maintenance (see paragraph 14).
- Adhere to the determined maintenance conditions (see paragraph 14).
- Check the wear parts, as required, and exchange them in the defined intervals (see paragraph 14).
- Check the adjustment of the system joint during maintenance and correct it, if necessary (see paragraph 14).
- Check the functionality of the system joint during maintenance (see paragraph 14).
- The maximum load determined during the planning of the custom-made product shall not be exceeded by changes in the patient data (e.g. due to weight gain, growth or increased activity). If the determined maximum load on the system joints is exceeded, the system joint must no longer be used. When planning the custom-made product, expected changes in patient data need to be taken into account.
- The period of use of the system joints ends with the period of use of the custom-made product (orthosis).
- The multiple use of the system joint in another custom-made product is not allowed (see paragraph 21).

16. Storage

It is recommended to store the system joint in its original packaging until the custom-made product is produced.

17. Spare Parts

17.1 Exploded View Drawing NEURO LOCK MAX

The exploded view drawing of the **NEURO LOCK MAX** system knee joint also serves as an exemplary illustration for the **NEURO LOCK** system knee joint.

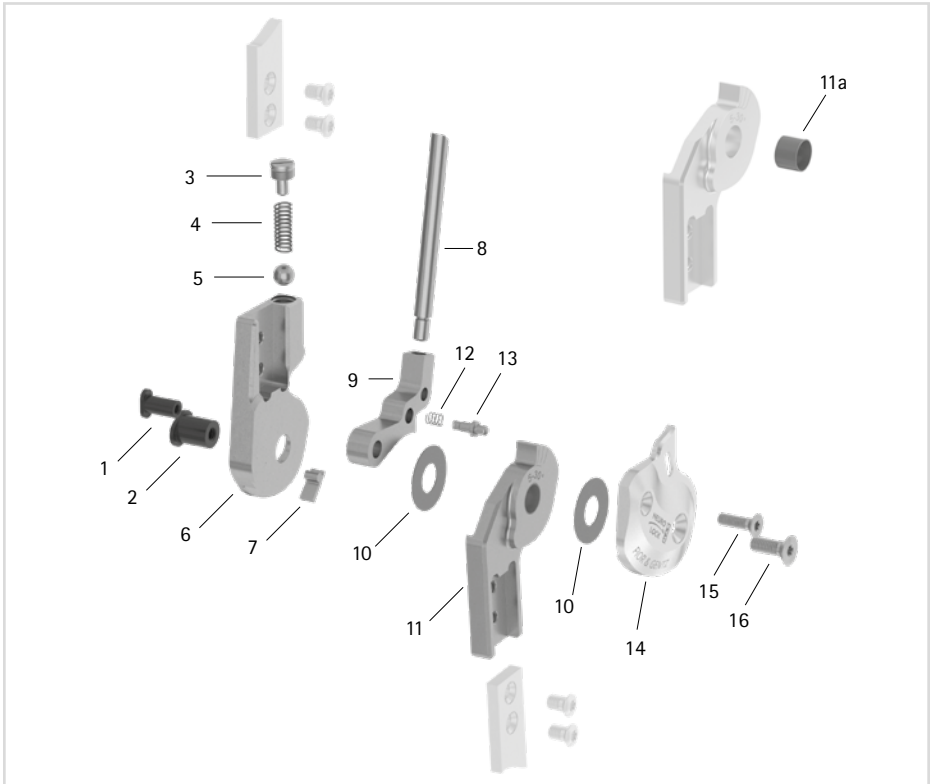

fig. 47

17.2 Exploded View Drawing NEURO FLEX MAX Lock Function

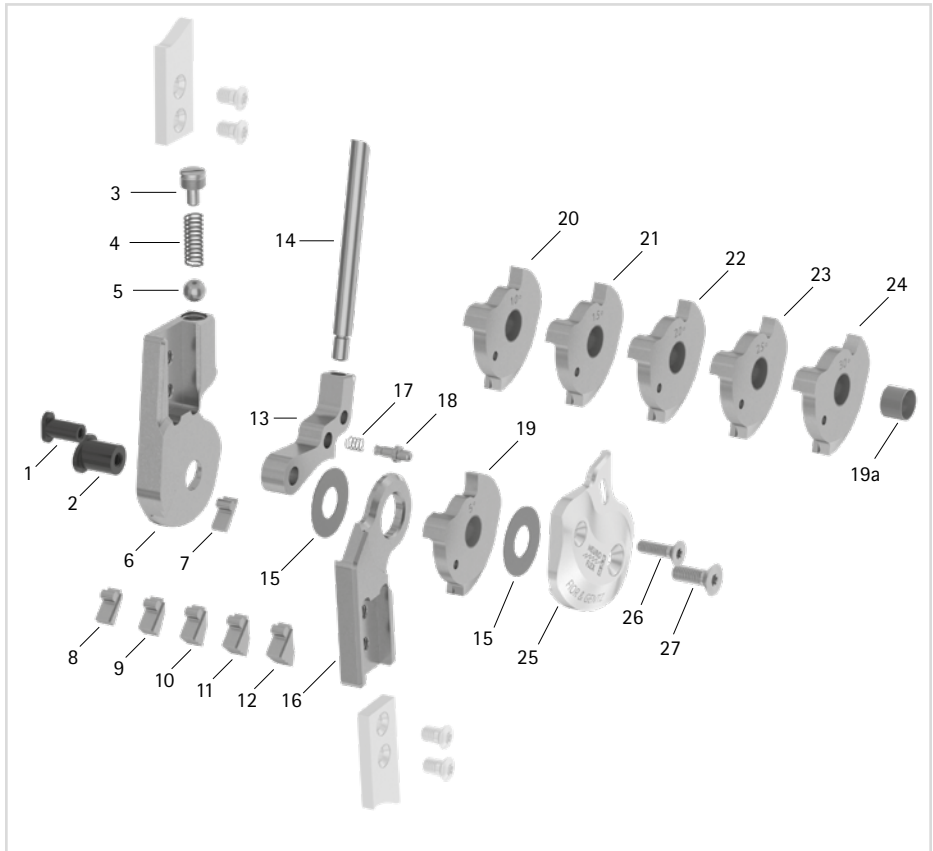

fig. 48

17.3 Exploded View Drawing NEURO FLEX MAX Step Lock Function

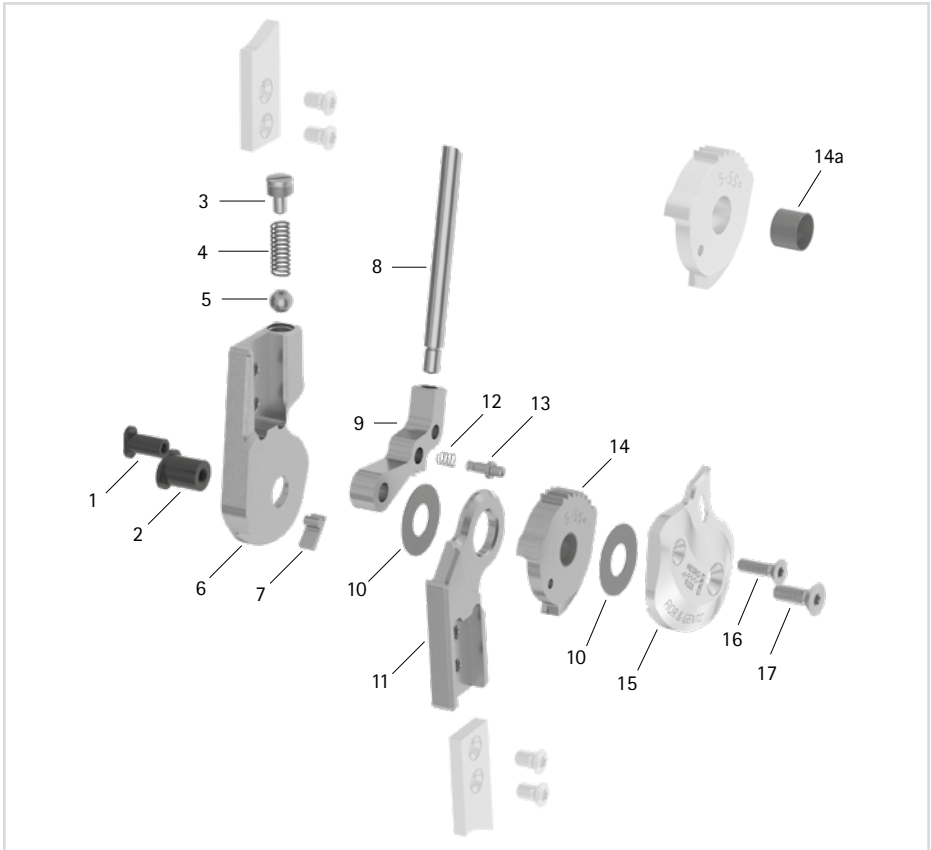

fig. 49

17.4 Spare Parts for the NEURO LOCK System Knee Joint

The assignment of the items as shown in the exploded view drawing of the NEURO LOCK MAX system knee joint serves as guidance. The spare parts of the NEURO LOCK system knee joint are not identical to the picture.

Item	Article Number for System Width			Description
	14mm	16mm	20mm	
1	SB6044-L0610	SB6044-L0750	SB6044-L0820	bearing nut (locking pawl)
2	SB8554-L0610	SB9664-L0750	SB9664-L0820	bearing nut (joint axis)
3	SC2106-L05	SC9606-L09	SC9606-L09	pressure screw
4	FE1414-02	FE1414-02	FE1414-02	coil spring
5	KU1005-ST	KU1005-ST	KU1005-ST	ball
6	SK0402-2L/ST	SK0403-2L/ST	SK0405-2L/ST	upper part, left lateral or right medial, straight, steel
6	SK0402-2R/ST	SK0403-2R/ST	SK0405-2R/ST	upper part, left medial or right lateral, straight, steel
6	SK0402-2L/TI	SK0403-2L/TI	SK0405-2L/TI	upper part, left lateral or right medial, straight, titanium
6	SK0402-2R/TI	SK0403-2R/TI	SK0405-2R/TI	upper part, left medial or right lateral, straight, titanium
7	SK9602-E005	SK9603-E005	SK9605-E005	5° extension stop
8	SK0492-ST	SK0495-ST	SK0495-ST	lever extension
9	SK0472-*	SK0473-*	SK0475-*	locking pawl*
10	GS1609-**	GS1910-**	GS2210-**	sliding washer**
11	SK0412-2L/ST	SK0413-2L/ST	SK0415-2L/ST	5° lower part with sliding bushing, 5°–30°, left lateral or right medial, straight, steel
11	SK0412-2R/ST	SK0413-2R/ST	SK0415-2R/ST	5° lower part with sliding bushing, 5°–30°, left medial or right lateral, straight, steel
11	SK0412-2L/TI	SK0413-2L/TI	SK0415-2L/TI	5° lower part with sliding bushing, 5°–30°, left lateral or right medial, straight, titanium
11	SK0412-2R/TI	SK0413-2R/TI	SK0415-2R/TI	5° lower part with sliding bushing, 5°–30°, left medial or right lateral, straight, titanium
11	SK0432-2L/ST	SK0433-2L/ST	SK0435-2L/ST	5° lower part with sliding bushing, 5°–30°, left lateral or right medial, bent inwards, steel
11	SK0432-2R/ST	SK0433-2R/ST	SK0435-2R/ST	5° lower part with sliding bushing, 5°–30°, left medial or right lateral, bent inwards, steel
11	SK0432-2L/TI	SK0433-2L/TI	SK0435-2L/TI	5° lower part with sliding bushing, 5°–30°, left lateral or right medial, bent inwards, titanium
11	SK0432-2R/TI	SK0433-2R/TI	SK0435-2R/TI	5° lower part with sliding bushing, 5°–30°, left medial or right lateral, bent inwards, titanium
11a	BP1009-L029	BP1110-L035	BP1110-L040	sliding bushing

Item	Article Number for System Width			Description
	14mm	16mm	20mm	
14	SK0452-2L/AL	SK0453-2L/AL	SK0455-2L/AL	cover plate, left lateral or right medial, aluminium
14	SK0452-2R/AL	SK0453-2R/AL	SK0455-2R/AL	cover plate, left medial or right lateral, aluminium
15	SC1404-L10	SC1404-L10	SC1404-L12	countersunk flat head screw with hexalobular socket
16	SC1405-L10	SC1405-L11	SC1405-L12	countersunk flat head screw with hexalobular socket (axle screw)
w/o fig.	SK0492-VS	SK0493-VS	SK0493-VS	connecting tube for lever extension
w/o fig.	SC0403-L08	SC0403-L10	SC0403-L10	pan head screw for exchanging extension stops

*** Locking Pawls NEURO LOCK**

14mm	Article Number for System Width	
	16mm	20mm
-	SK0473-TI038	-
SK0472-TI050	SK0473-TI050	SK0475-TI050
SK0472-TI063	SK0473-TI063	SK0475-TI063
-	SK0473-TI075	SK0475-TI075
-	SK0473-TI088	SK0475-TI088
-	SK0473-TI100	SK0475-TI100

**** Sliding Washers NEURO LOCK**

14mm	Article Number for System Width	
	16mm	20mm
	$\varnothing = 16\text{mm}$	$\varnothing = 19\text{mm}$
		$\varnothing = 22\text{mm}$
GS1609-040	GS1910-040	GS2210-040
GS1609-045	GS1910-045	GS2210-045
GS1609-050	GS1910-050	GS2210-050
GS1609-055	GS1910-055	GS2210-055
GS1609-060	GS1910-060	GS2210-060

17.5 Spare Parts for the NEURO LOCK MAX System Knee Joint

Item	Article Number for System Width				Description
	12mm	14mm	16mm	20mm	
1	SB6049-L0850	SB6049-L0950	SB6049-L1130	SB8559-L1290	bearing nut (locking pawl)
2	SB7049-L0850	SB8559-L0950	SB9669-L1130	SB1069-L1290	bearing nut (joint axis)
3	SC2106-L04	SC2107-L04	SC9608-L11	SC9609-L04/1	pressure screw
4	FE1414-01	FE1520-01	FE1527-01	FE2726-01	coil spring
5	KU1005-ST	KU1006-ST	KU1007-ST	KU1008-ST	ball
6	SK0701-2L/TI	SK0702-2L/TI	SK0703-2L/TI	SK0705-2L/TI	upper part, left lateral or right medial, straight, titanium
6	SK0701-2R/TI	SK0702-2R/TI	SK0703-2R/TI	SK0705-2R/TI	upper part, left medial or right lateral, straight, titanium
7	SK9801-E005	SK9802-E005	SK9803-E005	SK9805-E005	5° extension stop
8	SK0492-ST	SK0492-ST	SK0495-ST	SK0495-ST	lever extension
9	SK0771-*	SK0772-*	SK0773-*	SK0775-*	locking pawl*
10	GS1807-***	GS2009-***	GS2210-***	GS2411-***	sliding washer***
11	SK0811-2L/TI	SK0812-2L/TI	SK0813-2L/TI	SK0815-2L/TI	5° lower part with sliding bushing, 5°-30°, left lateral or right medial, straight, titanium
11	SK0811-2R/TI	SK0812-2R/TI	SK0813-2R/TI	SK0815-2R/TI	5° lower part with sliding bushing, 5°-30°, left medial or right lateral, straight, titanium
11	SK0831-2L/TI	SK0832-2L/TI	SK0833-2L/TI	SK0835-2L/TI	5° lower part with sliding bushing, 5°-30°, left lateral or right medial, bent inwards, titanium
11	SK0831-2R/TI	SK0832-2R/TI	SK0833-2R/TI	SK0835-2R/TI	5° lower part with sliding bushing, 5°-30°, left medial or right lateral, bent inwards, titanium
11a	BP0807-L056	BP1009-L065	BP1110-L078	BP1211-L090	sliding bushing
12	FE1407-01	FE1411-02	FE1411-02	FE1411-02	coil spring
13	SK0771-20	SK0772-20	SK0773-20	SK0775-20	locating pin for adjusting the permanent unlock function
14	SK0861-2L/AL	SK0862-2L/AL	SK0863-2L/AL	SK0865-2L/AL	cover plate, left lateral or right medial, aluminium
14	SK0861-2R/AL	SK0862-2R/AL	SK0863-2R/AL	SK0865-2R/AL	cover plate, left medial or right lateral, aluminium
15	SC1404-L12	SC1404-L12	SC1404-L14	SC1405-L14	countersunk flat head screw with hexalobular socket
16	SC1404-L12	SC1405-L12	SC1405-L14	SC1406-L14	countersunk flat head screw with hexalobular socket (axle screw)
w/o fig.	SK0492-VS	SK0492-VS	SK0493-VS	SK0493-VS	connecting tube for lever extension

Item	Article Number for System Width				Description
	12mm	14mm	16mm	20mm	
w/o fig.	SC0403-L08	SC0403-L08	SC0403-L10	SC0403-L10	pan head screw for exchanging extension stops

17.6 Spare Parts for the NEURO FLEX MAX System Knee Joint Lock Function

Item	Article Number for System Width				Description
	12mm	14mm	16mm	20mm	
1	SB6049-L0850	SB6049-L0950	SB6049-L1130	SB8559-L1290	bearing nut (locking pawl)
2	SB7049-L0850	SB8559-L0950	SB9669-L1130	SB1069-L1290	bearing nut (joint axis)
3	SC2106-L04	SC2107-L04	SC9608-L11	SC9609-L04/1	pressure screw
4	FE1414-01	FE1520-01	FE1527-01	FE2726-01	coil spring
5	KU1005-ST	KU1006-ST	KU1007-ST	KU1008-ST	ball
6	SK0701-2L/TI	SK0702-2L/TI	SK0703-2L/TI	SK0705-2L/TI	upper part, left lateral or right medial, straight, titanium
6	SK0701-2R/TI	SK0702-2R/TI	SK0703-2R/TI	SK0705-2R/TI	upper part, left medial or right lateral, straight, titanium
7	SK9801-E005	SK9802-E005	SK9803-E005	SK9805-E005	5° extension stop
8	SK9801-E010	SK9802-E010	SK9803-E010	SK9805-E010	10° extension stop
9	SK9801-E015	SK9802-E015	SK9803-E015	SK9805-E015	15° extension stop
10	SK9801-E020	SK9802-E020	SK9803-E020	SK9805-E020	20° extension stop
11	SK9801-E025	SK9802-E025	SK9803-E025	SK9805-E025	25° extension stop
12	SK9801-E030	SK9802-E030	SK9803-E030	SK9805-E030	30° extension stop
13	SK0771-*	SK0772-*	SK0773-*	SK0775-*	locking pawl*
14	SK0492-ST	SK0492-ST	SK0495-ST	SK0495-ST	lever extension
15	GS1807-***	GS2009-***	GS2210-***	GS2411-***	sliding washer***
16	SK0711-L/TI	SK0712-L/TI	SK0713-L/TI	SK0715-L/TI	lower part, left lateral or right medial, straight, titanium
16	SK0711-R/TI	SK0712-R/TI	SK0713-R/TI	SK0715-R/TI	lower part, left medial or right lateral, straight, titanium
16	SK0731-L/TI	SK0732-L/TI	SK0733-L/TI	SK0735-L/TI	lower part, left lateral or right medial, bent inwards, titanium
16	SK0731-R/TI	SK0732-R/TI	SK0733-R/TI	SK0735-R/TI	lower part, left medial or right lateral, bent inwards, titanium
17	FE1407-01	FE1411-02	FE1411-02	FE1411-02	coil spring

Item	Article Number for System Width				Description
	12mm	14mm	16mm	20mm	
18	SK0771-20	SK0772-20	SK0773-20	SK0775-20	locating pin for adjusting the permanent unlock function
19	SK0781-2L/TI	SK0782-2L/TI	SK0783-2L/TI	SK0785-2L/TI	5° flexion stop disc with sliding bushing, left lateral or right medial, titanium
19	SK0781-2R/TI	SK0782-2R/TI	SK0783-2R/TI	SK0785-2R/TI	5° flexion stop disc with sliding bushing, left medial or right lateral, titanium
20	SK0781-3L/TI	SK0782-3L/TI	SK0783-3L/TI	SK0785-3L/TI	10° flexion stop disc with sliding bushing, left lateral or right medial, titanium
20	SK0781-3R/TI	SK0782-3R/TI	SK0783-3R/TI	SK0785-3R/TI	10° flexion stop disc with sliding bushing, left medial or right lateral, titanium
21	SK0781-4L/TI	SK0782-4L/TI	SK0783-4L/TI	SK0785-4L/TI	15° flexion stop disc with sliding bushing, left lateral or right medial, titanium
21	SK0781-4R/TI	SK0782-4R/TI	SK0783-4R/TI	SK0785-4R/TI	15° flexion stop disc with sliding bushing, left medial or right lateral, titanium
22	SK0781-5L/TI	SK0782-5L/TI	SK0783-5L/TI	SK0785-5L/TI	20° flexion stop disc with sliding bushing, left lateral or right medial, titanium
22	SK0781-5R/TI	SK0782-5R/TI	SK0783-5R/TI	SK0785-5R/TI	20° flexion stop disc with sliding bushing, left medial or right lateral, titanium
23	SK0781-6L/TI	SK0782-6L/TI	SK0783-6L/TI	SK0785-6L/TI	25° flexion stop disc with sliding bushing, left lateral or right medial, titanium
23	SK0781-6R/TI	SK0782-6R/TI	SK0783-6R/TI	SK0785-6R/TI	25° flexion stop disc with sliding bushing, left medial or right lateral, titanium
24	SK0781-7L/TI	SK0782-7L/TI	SK0783-7L/TI	SK0785-7L/TI	30° flexion stop disc with sliding bushing, left lateral or right medial, titanium
24	SK0781-7R/TI	SK0782-7R/TI	SK0783-7R/TI	SK0785-7R/TI	30° flexion stop disc with sliding bushing, left medial or right lateral, titanium
19a	BP0807-L056	BP1009-L065	BP1110-L078	BP1211-L090	sliding bushing
25	SK0761-2L/AL	SK0762-2L/AL	SK0763-2L/AL	SK0765-2L/AL	cover plate, left lateral or right medial, aluminium
25	SK0761-2R/AL	SK0762-2R/AL	SK0763-2R/AL	SK0765-2R/AL	cover plate, left medial or right lateral, aluminium
26	SC1404-L12	SC1404-L12	SC1404-L14	SC1405-L14	countersunk flat head screw with hexalobular socket

Item	Article Number for System Width				Description
	12mm	14mm	16mm	20mm	
27	SC1404-L12	SC1405-L12	SC1405-L14	SC1406-L14	countersunk flat head screw with hexalobular socket (axle screw)
w/o fig.	SK0492-VS	SK0492-VS	SK0493-VS	SK0493-VS	connecting tube for lever extension
w/o fig.	SC0403-L08	SC0403-L08	SC0403-L10	SC0403-L10	pan head screw for exchanging extension stops

* Locking Pawls NEURO LOCK MAX/NEURO FLEX MAX Lock Function				
12mm	Article Number for System Width			Leg
	14mm	16mm	20mm	
SK0771-L/025	-	-	SK0775-L/025	left lateral or right medial
SK0771-L/038	SK0772-L/038	SK0773-L/038	SK0775-L/038	left lateral or right medial
SK0771-L/044	-	-	SK0775-L/044	left lateral or right medial
SK0771-L/050	SK0772-L/050	SK0773-L/050	SK0775-L/050	left lateral or right medial
-	SK0772-L/056	SK0773-L/056	SK0775-L/056	left lateral or right medial
SK0771-L/063	SK0772-L/063	SK0773-L/063	SK0775-L/063	left lateral or right medial
-	SK0772-L/069	SK0773-L/069	-	left lateral or right medial
-	SK0772-L/075	SK0773-L/075	SK0775-L/075	left lateral or right medial
-	SK0772-L/088	SK0773-L/088	SK0775-L/088	left lateral or right medial
-	SK0772-L/100	SK0773-L/100	-	left lateral or right medial
SK0771-R/025	-	-	SK0775-R/025	left medial or right lateral
SK0771-R/038	SK0772-R/038	SK0773-R/038	SK0775-R/038	left medial or right lateral
SK0771-R/044	-	-	SK0775-R/044	left medial or right lateral
SK0771-R/050	SK0772-R/050	SK0773-R/050	SK0775-R/050	left medial or right lateral
-	SK0772-R/056	SK0773-R/056	SK0775-R/056	left medial or right lateral
SK0771-R/063	SK0772-R/063	SK0773-R/063	SK0775-R/063	left medial or right lateral
-	SK0772-R/069	SK0773-R/069	-	left medial or right lateral
-	SK0772-R/075	SK0773-R/075	SK0775-R/075	left medial or right lateral
-	SK0772-R/088	SK0773-R/088	SK0775-R/088	left medial or right lateral
-	SK0772-R/100	SK0773-R/100	-	left medial or right lateral

17.7 Spare Parts for the NEURO FLEX MAX System Knee Joint Step Lock Function

Item	Article Number for System Width				Description
	12mm	14mm	16mm	20mm	
1	SB6049-L0850	SB6049-L0950	SB6049-L1130	SB8559-L1290	bearing nut (step lock pawl)
2	SB7049-L0850	SB8559-L0950	SB9669-L1130	SB1069-L1290	bearing nut (joint axis)
3	SC2106-L04	SC2107-L04	SC9608-L11	SC9609-L04/1	pressure screw
4	FE1414-01	FE1520-01	FE1527-01	FE2726-01	coil spring
5	KU1005-ST	KU1006-ST	KU1007-ST	KU1008-ST	ball
6	SK0701-2L/TI	SK0702-2L/TI	SK0703-2L/TI	SK0705-2L/TI	upper part, left lateral or right medial, straight, titanium
6	SK0701-2R/TI	SK0702-2R/TI	SK0703-2R/TI	SK0705-2R/TI	upper part, left medial or right lateral, straight, titanium
7	SK9801-E005	SK9802-E005	SK9803-E005	SK9805-E005	5° extension stop
8	SK0492-ST	SK0492-ST	SK0495-ST	SK0495-ST	lever extension
9	SK0761-**	SK0762-**	SK0763-**	SK0765-**	step lock pawl**
10	GS1807-***	GS2009-***	GS2210-***	GS2411-***	sliding washer***
11	SK0711-L/TI	SK0712-L/TI	SK0713-L/TI	SK0715-L/TI	lower part, left lateral or right medial, straight, titanium
11	SK0711-R/TI	SK0712-R/TI	SK0713-R/TI	SK0715-R/TI	lower part, left medial or right lateral, straight, titanium
11	SK0731-L/TI	SK0732-L/TI	SK0733-L/TI	SK0735-L/TI	lower part, left lateral or right medial, bent inwards, titanium
11	SK0731-R/TI	SK0732-R/TI	SK0733-R/TI	SK0735-R/TI	lower part, left medial or right lateral, bent inwards, titanium
12	FE1407-01	FE1411-02	FE1411-02	FE1411-02	coil spring
13	SK0771-20	SK0772-20	SK0773-20	SK0775-20	locating pin for adjusting the permanent unlock function
14	SK0791-2L/TI	SK0792-2L/TI	SK0793-2L/TI	SK0795-2L/TI	5° step lock stop disc with sliding bushing, 5°-55°, in 10° steps, left lateral or right medial, titanium
14	SK0791-2R/TI	SK0792-2R/TI	SK0793-2R/TI	SK0795-2R/TI	5° step lock stop disc with sliding bushing, 5°-55°, in 10° steps, left medial or right lateral, titanium
14a	BP0807-L056	BP1009-L065	BP1110-L078	BP1211-L090	sliding bushing
15	SK0761-2L/AL	SK0762-2L/AL	SK0763-2L/AL	SK0765-2L/AL	cover plate, left lateral or right medial, aluminium
15	SK0761-2R/AL	SK0762-2R/AL	SK0763-2R/AL	SK0765-2R/AL	cover plate, left medial or right lateral, aluminium
16	SC1404-L12	SC1404-L12	SC1404-L14	SC1405-L14	countersunk flat head screw with hexalobular socket
17	SC1404-L12	SC1405-L12	SC1405-L14	SC1406-L14	countersunk flat head screw with hexalobular socket (axle screw)

Item	Article Number for System Width				Description
	12mm	14mm	16mm	20mm	
w/o fig.	SK0492-VS	SK0492-VS	SK0493-VS	SK0493-VS	connecting tube for lever extension
w/o fig.	SC0403-L08	SC0403-L08	SC0403-L10	SC0403-L10	pan head screw for exchanging extension stops

**** Step Lock Pawls NEURO FLEX MAX Step Lock Function**

Article Number for System Width				
12mm	14mm	16mm	20mm	Leg
SK0761-L/025	SK0762-L/025	SK0763-L/025	SK0765-L/025	left lateral or right medial
SK0761-L/038	-	SK0763-L/038	-	left lateral or right medial
SK0761-L/050	SK0762-L/050	SK0763-L/050	SK0765-L/050	left lateral or right medial
SK0761-L/063	SK0762-L/063	SK0763-L/063	SK0765-L/063	left lateral or right medial
SK0761-L/075	SK0762-L/075	SK0763-L/075	SK0765-L/075	left lateral or right medial
-	SK0762-L/088	SK0763-L/088	SK0765-L/088	left lateral or right medial
-	SK0762-L/100	SK0763-L/100	-	left lateral or right medial
SK0761-R/025	SK0762-R/025	SK0763-R/025	SK0765-R/025	left medial or right lateral
SK0761-R/038	-	SK0763-R/038	-	left medial or right lateral
SK0761-R/050	SK0762-R/050	SK0763-R/050	SK0765-R/050	left medial or right lateral
SK0761-R/063	SK0762-R/063	SK0763-R/063	SK0765-R/063	left medial or right lateral
SK0761-R/075	SK0762-R/075	SK0763-R/075	SK0765-R/075	left medial or right lateral
-	SK0762-R/088	SK0763-R/088	SK0765-R/088	left medial or right lateral
-	SK0762-R/100	SK0763-R/100	-	left medial or right lateral

***** Sliding Washers NEURO LOCK MAX/NEURO FLEX MAX**

Article Number for System Width			
12mm	14mm	16mm	20mm
Ø = 18mm	Ø = 20mm	Ø = 22mm	Ø = 24mm
GS1807-040	GS2009-040	GS2210-040	GS2411-040
GS1807-045	GS2009-045	GS2210-045	GS2411-045
GS1807-050	GS2009-050	GS2210-050	GS2411-050
GS1807-055	GS2009-055	GS2210-055	GS2411-055
GS1807-060	GS2009-060	GS2210-060	GS2411-060

18. Disposal

Dispose of the system joint and its individual parts properly. The product must not be disposed of with the residual waste (fig. 50). Please comply with the applicable national laws and local regulations for the proper recycling of recyclable materials.



For proper disposal, it is necessary to demount the system joint from the orthosis.



fig. 50

19. Signs and Symbols



CE labelling according to Regulation (EU) 2017/745 for medical devices



medical device



article number



manufacturer



batch code



serial number



follow the instructions for use



single patient – multiple uses



Unique Device Identifier – product identification number

20. CE Conformity

We declare that our medical devices as well as our accessories for medical devices are in conformity with the requirements of Regulation (EU) 2017/745. Therefore, the FIOR & GENTZ products bear the CE marking.

21. Legal Information

With the purchase of this product, our General Terms and Conditions of Business Transactions, Sales, Delivery and Payment will apply. The warranty expires, for example, if the product is mounted several times. Please note that the product is not supposed to be combined with other components or materials than with those recommended in the configuration result of the FIOR & GENTZ Orthosis Configurator. The combination of the product with products from other manufacturers is not permitted.

The information in these instructions for use is valid at the date of printing. The contained product information serves as guidelines. Subject to technical modifications.

All copy rights, particularly the distribution, copy and translation of these instructions for use or any part of it, must be authorised by FIOR & GENTZ Gesellschaft für Entwicklung und Vertrieb von orthopädietechnischen Systemen mbH. Reprints, copies and any other electronic reproduction, even partial, must be authorised in writing by FIOR & GENTZ Gesellschaft für Entwicklung und Vertrieb von orthopädietechnischen Systemen mbH.

.....

22. Information for the Treatment Documentation

Add these instructions for use to your treatment documentation!

Patient Data

Name	
Address	
Postcode, City	
Home Telephone	
Telephone at Work	
Insurance	
Insurance No.	
Attending Physician	
Diagnosis	

23. Handing Over the Orthosis

The qualified specialist in orthopaedic technology has also handed over the instructions for use for patients as well as the orthosis service passport to you as a patient, parent or care team. By means of these instructions for use, the functions and handling of the orthosis were explained to you in detail. You will find the next maintenance appointment in the orthosis service passport. Bring the orthosis service passport with you to every maintenance appointment.



Place, Date

Signature Patient

Leg Side

left right

Mounted Locking Pawl

SK _____ - _____

Mounted Step Lock Pawl

SK _____ - _____

Mounted Sliding Washer

1. GS _____ - _____

2. GS _____ - _____

